

EKX Powered Loudspeakers

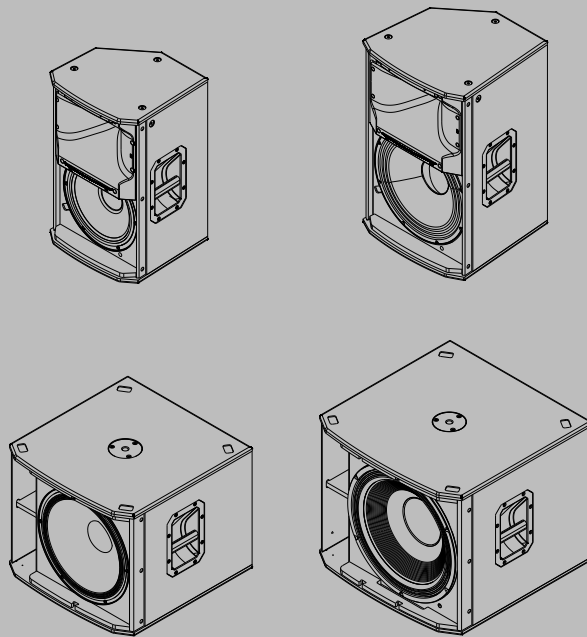





Table of contents

1	Safety	4
1.1	Important safety instructions	4
1.2	Suspension	5
1.3	FCC information	6
1.4	Precautions	6
1.5	Notices	6
2	Description	8
2.1	System features	9
2.2	Quick Setup	10
3	System overview	12
3.1	Dimensions	12
4	Tripod and floor monitor operation	13
4.1	Tripod or pole mount	13
4.2	Floor monitor	15
5	Suspension	16
6	Amplifier DSP	20
6.1	Amplifier DSP controls	20
6.2	System status	22
6.3	DSP controls	23
6.3.1	Full-Range loudspeaker DSP control menu	24
6.3.2	Subwoofer DSP control menu	30
7	Recommended configurations	35
7.1	Daisy-chaining full-range systems	35
7.2	MP3 player MONO configuration	36
7.3	MP3 player STEREO configuration	37
7.4	Using full-range systems as monitors	38
7.5	Stacking full-range systems with subwoofers	39
7.6	Cardioid Control Technology	40
8	Troubleshooting	42
9	Technical data	44
9.1	Frequency response	46

1 Safety

1.1 Important safety instructions

 <p>WARNING: TO REDUCE THE RISK OF FIRE OR ELECTRIC SHOCK, DO NOT OVEREXPOSE THIS APPLIANCE TO RAIN OR MOISTURE</p> <p>AVIS: RISQUE DE CHOC ELECTRIQUE, NE PAS OUVRIR.</p> <p>WARNING: THE MAINS PLUG OR AC INLET IS USED AS A DISCONNECT DEVICE. THE DISCONNECT DEVICE SHALL REMAIN READILY OPERABLE.</p> <p>WARNING: CONNECT ONLY TO MAINS SOCKET WITH PROTECTIVE EARTHING CONNECTION.</p> <p>WARNING: TO REDUCE THE RISK OF ELECTRIC SHOCK, DO NOT REMOVE COVER (OR BACK) AS THERE ARE NO USER-SERVICABLE PARTS INSIDE. REFER SERVICING TO QUALIFIED PERSONNEL.</p>		<p>The lightning flash with arrowhead symbol, within an equilateral triangle is intended to alert the user to the presence of uninsulated “dangerous voltage” within the product’s enclosure that may be sufficient magnitude to constitute a risk of electric shock to persons.</p>
		<p>The exclamation point within an equilateral triangle is intended to alert the user to the presence of important operating and maintenance (servicing) instructions in the literature accompanying the appliance.</p>
		<p>The asterisk within an equilateral triangle is intended to inform the user to necessary installation or removal instructions regarding equipment or hardware use relating to the system.</p>

1. Read these instructions.
2. Keep these instructions.
3. Heed all warnings.
4. Follow all instructions.
5. Do not use this apparatus near water.
6. Clean only with a dry cloth.
7. Do not block any ventilation openings. Install in accordance with the manufacturer's instructions.
8. Do not install near any heat sources such as radiators, heat registers, stoves, or other apparatus (including amplifiers) that produce heat.
9. Do not defeat the safety purpose of the polarized or grounding-type plug. A polarized plug has two blades with one wider than the other. A grounding type plug has two blades and a third grounding prong. The wide blade or the third prong is provided for your safety. If the provided plug does not fit into your outlet, consult an electrician for replacement of the obsolete outlet.
10. Protect the power cord from being walked on or pinched particularly at plugs, convenience receptacles, and the point where they exit from the apparatus.
11. Only use attachments/accessories specified by the manufacturer.
12. Use only with the cart, stand, tripod, bracket, or table specified by the manufacturer, or with the apparatus. When a cart is used, use caution when moving the cart/apparatus combination to avoid injury from tip-over.
13. Unplug the apparatus during lightning storms or when unused for long periods of time.

14. Refer all servicing to qualified service personnel. Servicing is required when the apparatus has been damaged in any way, such as power-supply cord or plug is damaged, liquid has been spilled or objects have fallen into the apparatus, the apparatus has been exposed to rain or moisture, does not operate normally, or has been dropped.
15. No naked flame sources, such as lighted candles, should be placed on the apparatus.
16. To reduce the risk of fire or electric shock, do not expose this apparatus to rain or moisture. The apparatus should not be exposed to dripping or splashing. Objects filled with liquids, such as vases should not be placed on apparatus.
17. Do not block any ventilation openings. Install in accordance with the manufacturer's instructions.
18. Minimum 60 cm (2 ft) distances around the apparatus for sufficient ventilation.
19. The ventilation should not be impeded by covering the ventilation openings with items, such as newspapers, table-cloths, curtains, etc.
20. To completely disconnect AC power from this apparatus, the power supply cord must be unplugged.

1.2 Suspension

Warning!



Suspending any object is potentially dangerous and should only be attempted by individuals who have a thorough knowledge of the techniques and regulations of suspending objects overhead. Electro-Voice strongly recommends that loudspeakers be suspended taking into account all current national, federal, state, and local laws and regulations. It is the responsibility of the installer to ensure all loudspeakers are safely installed in accordance with all such requirements. When loudspeakers are suspended, Electro-Voice strongly recommends the system be inspected at least once per year or as laws and regulations require. If any sign of weakness or damage is detected, remedial action should be taken immediately. The user is responsible for making sure the wall, ceiling, or structure is capable of supporting all objects suspended overhead. Any hardware used to suspend a loudspeaker not associated with Electro-Voice is the responsibility of others.

Warning!



Do not suspend this product in any other manner than explicitly described in this manual, or Electro-Voice installation guides. Do NOT use handles to suspend the loudspeaker. Handles on Electro-Voice loudspeakers are intended to only be used for temporary transport by people. Items, such as fiber rope, wire rope, cables, or other types of materials cannot be used to suspend loudspeaker from the handles.

Warning!



This product is not designed to be suspended. Do NOT use handles or any other method to suspend the loudspeaker. Handles on Electro-Voice loudspeakers are intended to only be used for temporary transport by people. Items, such as fiber rope, wire rope, cables, or other types of materials cannot be used to suspend loudspeaker from the handles.





1.3 FCC information

Changes or modifications not expressly approved by the party responsible for compliance could void the user's authority to operate the equipment.

Note: This equipment has been tested and found to comply with the limits for a Class B digital device, pursuant to Part 15 of the FCC Rules. These limits are designed to provide reasonable protection against harmful interference in a residential installation. This equipment generates, uses, and can radiate radio frequency energy and, if not installed and used in accordance with the instructions, may cause harmful interference to radio communications. However, there is no guarantee that interference will not occur in a particular installation. If this equipment does cause harmful interference to radio or television reception, which can be determined by turning the equipment off and on, the user is encouraged to try to correct the interference by one or more of the following measures:

- Reorient or relocate the receiving antenna.
- Increase the separation between the equipment and receiver.
- Connect the equipment into an outlet on a circuit different from that to which the receiver is connected.
- Consult the dealer or an experienced radio/TV technician for help.

1.4 Precautions

	If an Electro-Voice loudspeaker is used outdoors on a sunny day, place the loudspeaker in a shaded or covered area. The loudspeaker amplifiers have protection circuits that temporarily shut the loudspeaker off when extremely high temperatures are reached. This can happen on hot days when the loudspeaker is in direct sunlight.
	Do not use Electro-Voice loudspeakers in an environment where temperatures are below 0°C (32°F) or exceed +35°C (95°F).
	Never expose an Electro-Voice loudspeaker to rain, water, or high moisture.
	Electro-Voice loudspeakers are easily capable of generating sound pressure levels sufficient to cause permanent hearing damage to anyone within normal coverage distance. Caution should be taken to avoid prolonged exposure to sound pressure levels exceeding 90dB.

1.5 Notices

Old electrical and electronic equipment

	This product and/or battery must be disposed of separately from household waste. Dispose such equipment according to local laws and regulations, to allow their reuse and/or recycling. This will help in conserving resources, and in protecting human health and the environment.
---	---

Copyright and disclaimer

All rights reserved. No part of this document may be reproduced or transmitted in any form by any means, electronic, mechanical, photocopying, recording, or otherwise, without the prior written permission of the publisher. For information on getting permission for reprints and excerpts, contact Electro-Voice.

All content including specifications, data, and illustrations in this manual are subject to change without prior notice.

2 Description

Thank you for choosing an Electro-Voice powered loudspeaker system. Please take time to consult the manual to understand all the features built into your EV system and fully utilize its performance capabilities.

The EKX series is the newest member of the Electro-Voice portable loudspeaker family, and combines legendary EV sound quality and reliability with the latest technology — all in a compact package suitable for a wide range of sound reinforcement scenarios, including musicians/DJs and live/club/installed sound applications. The EKX series features eight models (four powered and four passive), including 12-inch and 15-inch two-way models and 15-inch and 18-inch subwoofers.

EV-engineered components, Signal Synchronized Transducers (SST) waveguide design, and Class D amplifiers (up to 1500 W) coupled with Quick**Smart**DSP all work together to provide precise coverage and superior sound quality at high SPLs. EV's award-winning industrial design — with robust wood enclosures and durable EVCoat finish — ensures that EKX speakers look as great as they sound.

Powered EKX models feature high-efficiency Class-D power amplifiers (up to 1500 W) with integrated Quick**Smart**DSP, and deliver up to 134 dB SPL utilizing high-sensitivity transducers designed and engineered by EV (12-inch EVS-12M woofer / 15-inch EVS-15M woofer, each coupled with a DH-1M 1-inch titanium compression driver; 15-inch EVS-15C subwoofer / 18-inch EVS-18C subwoofer).

The EKX amplifier incorporates intelligent thermal management (with a variable-speed fan controlled by multiple onboard sensors) which ensures superior performance and reliability in demanding environmental conditions.

Powered models allow easy setup via four presets (Music, Live, Speech*, Club), sub/top system-match crossovers, three-band EQ*, five user-programmable presets (Store and Recall settings), visual monitoring of limiter status, input level control* and meters, and master volume control to ensure optimal gain structure. (* not available on subwoofers).

Adapted from our touring systems, EV's exclusive Cardioid Control Technology allows output to be steered towards the audience with up to 35 dB reduction on stage when multiple subs are deployed.

EKX powered models are ideal for portable and installed applications, with lightweight and compact 15-mm wood enclosures with internal bracing, durable EVCoat finish, eight M10 threaded mounting points (full-range only), aluminum pole-mounts, and all-metal handles.

2.1 System features

EKG-12P – 12-inch two-way powered loudspeaker system

- Quick**Smart**DSP features best-in-class processing, EV's signature single-knob user interface, and intuitive menu navigation via LCD.
- High-efficiency 1500 W Class-D power amplifier delivers up to 132 dB SPL via high-sensitivity transducers designed and engineered by EV.
- Intelligent thermal management with a variable-speed fan controlled by multiple onboard sensors.
- EV-patented Signal Synchronized Transducers (SST) waveguide design provides precise and consistent coverage, minimal distortion, and maximized acoustical loading.
- Lightweight, compact 15-mm wood enclosure with internal bracing, durable EVCoat finish, eight M10 threaded mounting points, aluminum pole-mounts, and all-metal handles.

EKG-15P – 15-inch two-way powered loudspeaker system

- Quick**Smart**DSP features best-in-class processing, EV's signature single-knob user interface, and intuitive menu navigation via LCD.
- High-efficiency 1500 W Class-D power amplifier delivers up to 134 dB SPL via next-generation high-sensitivity transducers designed and engineered by EV.
- Intelligent thermal management with a variable-speed fan controlled by multiple onboard sensors.
- EV-patented Signal Synchronized Transducers (SST) waveguide design provides precise and consistent coverage, minimal distortion, and maximized acoustical loading.
- Lightweight, compact 15-mm wood enclosure with internal bracing, durable EVCoat finish, eight M10 threaded mounting points, aluminum pole-mounts, and all-metal handles.

EKG-15SP – 15-inch powered subwoofer loudspeaker system

- Quick**Smart**DSP features best-in-class processing, EV's signature single-knob user interface, and intuitive menu navigation via LCD.
- Cardioid Control Technology allows output to be steered towards the audience with up to 35 dB reduction on stage when multiple subs are deployed.
- High-efficiency 1300 W Class-D power amplifier delivers up to 133 dB SPL utilizing high-sensitivity transducers designed and engineered by EV.
- Intelligent thermal management with a variable-speed fan controlled by multiple onboard sensors.
- Two XLR outputs for easy system expansion to additional loudspeakers or subwoofers. Large slot ports for low distortion and excellent bass extension. Metal grille reinforcement bar. M20 threaded pole mount plate.

EKG-18SP – 18-inch powered subwoofer loudspeaker system

- Quick**Smart**DSP features best-in-class processing, EV's signature single-knob user interface, and intuitive menu navigation via LCD.
- Cardioid Control Technology allows output to be steered towards the audience with up to 35 dB reduction on stage when multiple subs are deployed.
- High-efficiency 1300 W Class-D power amplifier delivers up to 134 dB SPL utilizing high-sensitivity transducers designed and engineered by EV.

- Intelligent thermal management with a variable-speed fan controlled by multiple onboard sensors.
- Two XLR outputs for easy system expansion to additional loudspeakers or subwoofers. Large slot ports for low distortion and excellent bass extension. Two metal grille reinforcement bar. M20 threaded pole mount plate.





2.2 Quick Setup

The EKX powered loudspeakers from Electro-Voice with carefully matched electronics and transducers. These products make it easy to set up a high quality system quickly with a minimum amount of cables and external electronics.

Full-Range loudspeaker

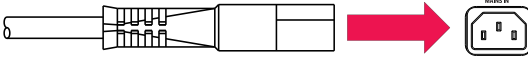
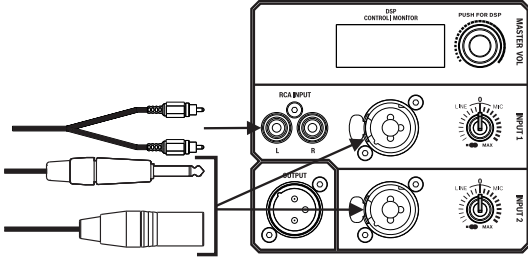
Models: EKX-12P and EKX-15P



To **set up a full-range loudspeaker**, do the following:

Step	Illustration
1. Connect the AC power cord from a grounded line receptacle to the MAINS IN.	
2. Connect the XLR, TRS, or RCA cable from an audio source to INPUT 1 or INPUT 2 .	
3. Adjust the input gain to $-\infty$ (infinity).	
4. Switch POWER to ON.	
5. From the DSP home screen, increase the input gain to the desired sound output.	
6. Adjust the MASTER VOL knob to the desired volume.	

Subwoofer

Models: EKX-15SP and EKX-18SP

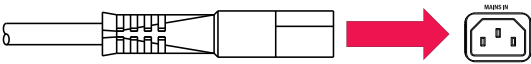
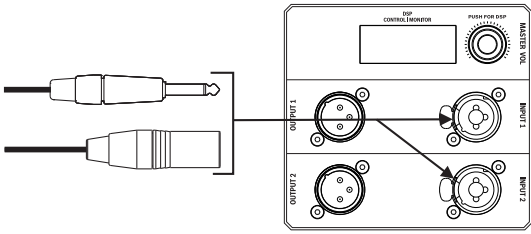
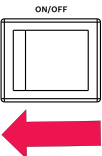
To **set up a subwoofer**, do the following:

Step	Illustration
1. Connect the AC power cord from a grounded line receptacle to the MAINS IN.	
2. Connect the XLR or TRS cable from an audio source to INPUT 1 or INPUT 2 .	
3. Switch POWER to ON.	
4. Adjust the MASTER VOL knob to the desired volume.	

3 System overview

3.1 Dimensions

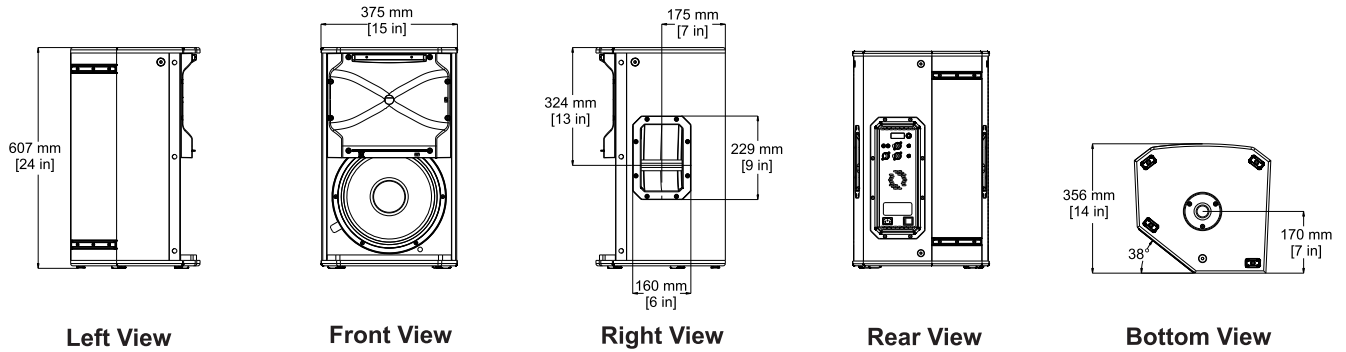

Figure 3.1: EKX-12P dimensions

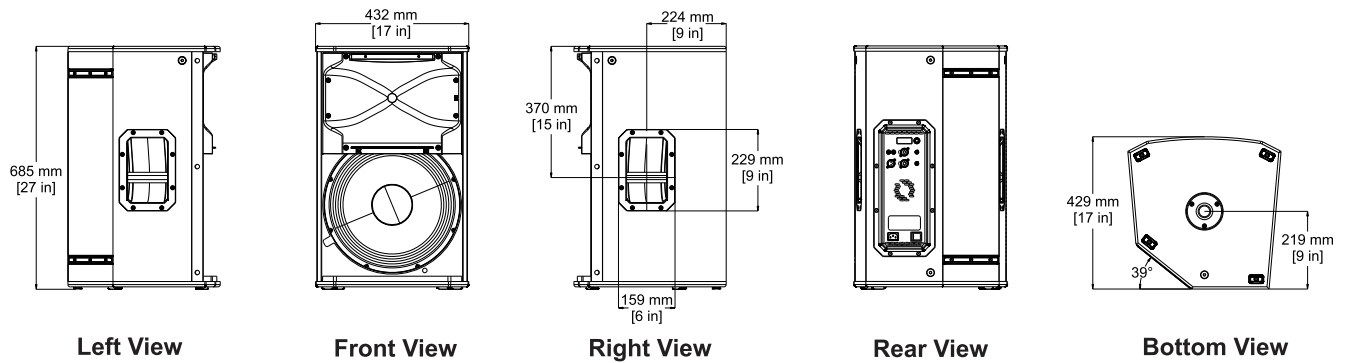

Figure 3.2: EKX-15P dimensions

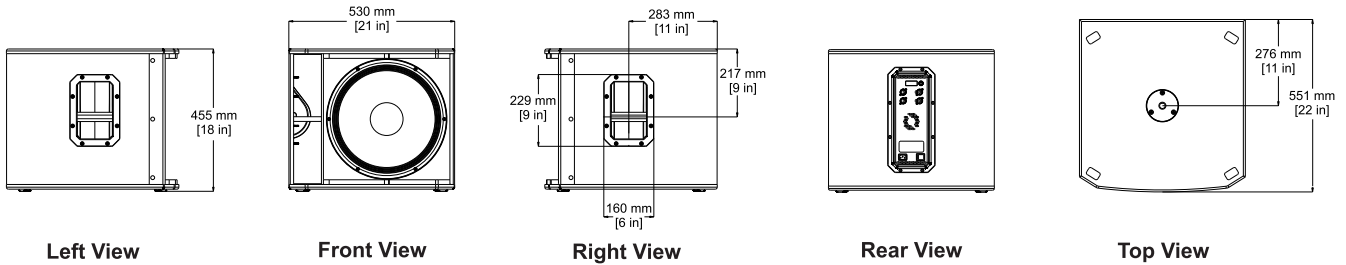

Figure 3.3: EKX-15SP dimensions

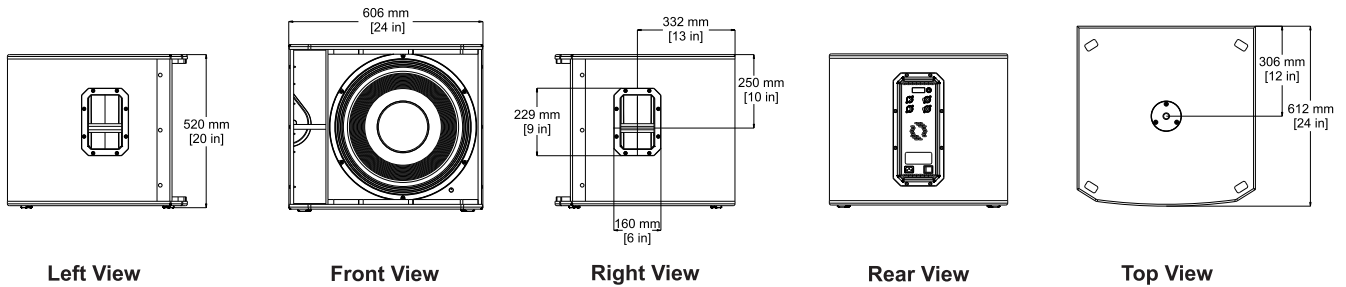

Figure 3.4: EKX-18SP dimensions

4 Tripod and floor monitor operation

4.1 Tripod or pole mount

EKG-12P and EKG-15P loudspeakers mount on a tripod stand or on a pole above a subwoofer.

Mounting a loudspeaker on a tripod stand

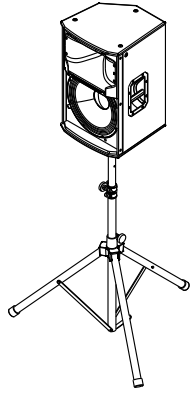

Figure 4.1: Full-Range models on a tripod stand



Caution!

Tripod is not evaluated for safety with this loudspeaker. Check the specifications of the tripod stand to be certain it is capable of supporting the weight of the loudspeaker.



Caution!

Two person lift and placement is recommended for the heavier loudspeakers. Single person lift and placement of heavier loudspeakers could cause injury.

To **mount a loudspeaker on a tripod stand**, do the following:

1. Place the **tripod stand** on a level stable surface.
 - Fully extend the legs on the tripod stand.
 - Do not compromise the tripod stands structural integrity by trying to make the stand taller.
 - Do not attempt to suspend more than one loudspeaker on a stand designed for a single loudspeaker.
2. Using two hands lift the **loudspeaker**.
3. Set the **pole cup** located on the bottom of the loudspeaker onto the pole.

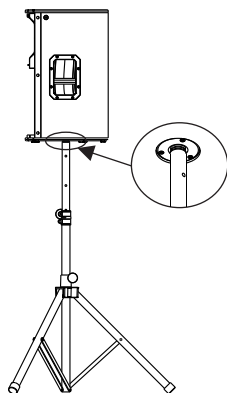

Mounting a loudspeaker on a pole

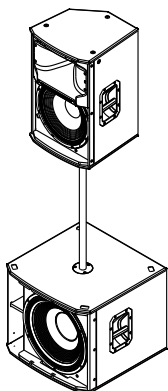

Figure 4.2: Full-Range/subwoofer stack with pole mount



Caution!

Two person lift and placement is recommended for the heavier loudspeakers. Single person lift and placement of heavier loudspeakers could cause injury.

To **mount a loudspeaker on a pole**, do the following:

1. Place the **subwoofer** on a level stable surface.
2. Insert the **M20 threaded pole** into the combo pole cup on the top of the subwoofer.
3. Turn the **M20 threaded pole** clockwise to secure the pole to the subwoofer.

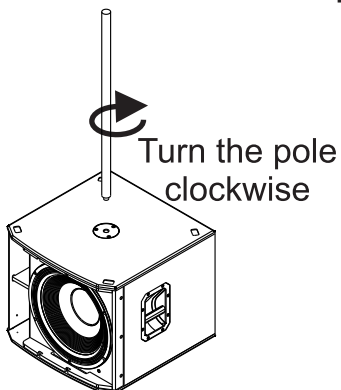

1. Using two hands lift the **loudspeaker**.
2. Set the **pole cup** located on the bottom of the loudspeaker onto the pole.

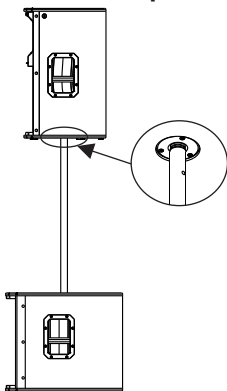

4.2 Floor monitor

EKX-12P and EKX-15P loudspeakers may be used as a floor monitor by placing the loudspeaker on the integral monitor angle.

To set up a loudspeaker as a floor monitor:

1. Place the loudspeaker on a level and stable surface.
2. Safely route cables to prevent injury to performers, production crew, and audience members.



Notice!

Secure cables with wire ties or tape whenever possible.

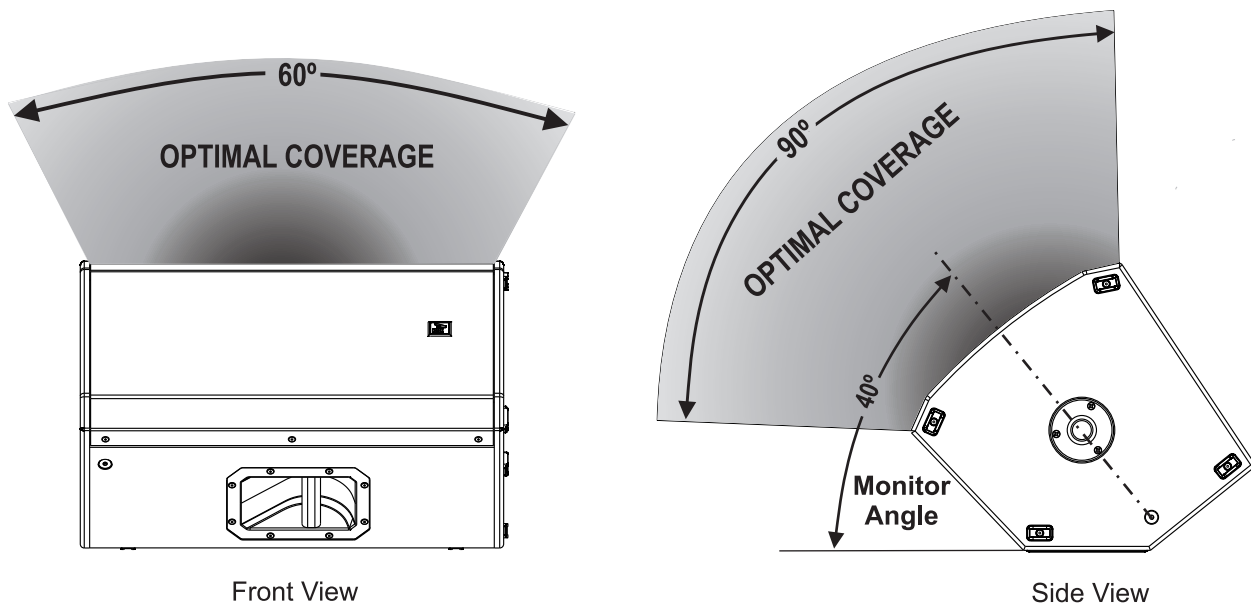

Figure 4.3: Optimum coverage in monitor position

5 Suspension

The EKX-12P and EKX-15P enclosures have eight (8) M10 threaded points; six (6) points on top of the enclosure and two (2) points on the bottom. Forged shoulder eyebolts rated for overhead suspension may be used to suspend an individual loudspeaker, such as the EBK-M10 accessory.

Warning!

Suspending any object is potentially dangerous and should only be attempted by individuals who have a thorough knowledge of the techniques and regulations of suspending objects overhead. Electro-Voice strongly recommends all loudspeakers be suspended taking into account all current national, federal, state, and local laws and regulations. It is the responsibility of the installer to ensure all loudspeakers are safely installed in accordance with all such requirements. When loudspeakers are suspended, Electro-Voice strongly recommends the system be inspected at least once per year or as laws and regulations require. If any sign of weakness or damage is detected, remedial action should be taken immediately. The user is responsible for making sure the wall, ceiling, or structure is capable of supporting all objects suspended overhead. Any hardware used to suspend a loudspeaker not associated with Electro-Voice is the responsibility of others.



Top Suspension Points

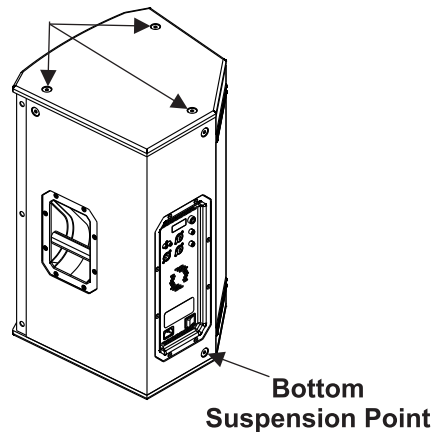

Figure 5.1: Suspension points

Prior to use, inspect the suspension points and associated hardware for any cracks, deformations, broken welds, corrosion, missing or damaged components which could reduce the suspension points strength. Replace any damaged hardware. Never exceed the limitations or maximum recommended load intended for the suspension points. As an added safety measure, it is suggested the user install an extra suspension point back to the building structural supports. This redundant safety point should have as little slack as possible (less than one inch is preferable). Prior to each use, inspect the loudspeaker enclosures for any cracks, deformations, missing or damaged components, which could reduce enclosure strength. Replace any loudspeaker systems damaged or missing hardware.

Installing the eyebolts

To **install the eyebolts**, do the following:

1. Remove the **M10 screws** from the suspension points.

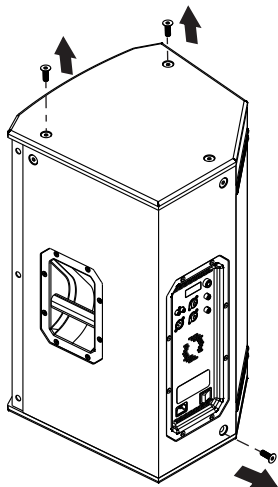

2. Replace the **M10 screw** with the fender washer and eyebolts.

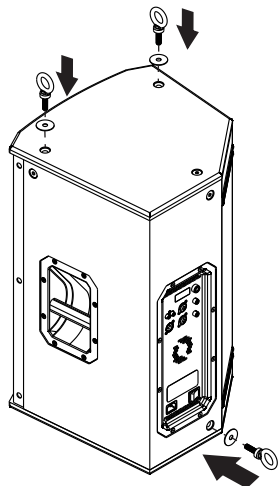

Notice!

If the eyebolts are removed reinstall the screws.
If the screws are not reinstalled air leaks occur in the enclosure, resulting in undesirable performance.



Warning!

Eyebolts must be fully seated and oriented in the plane of pull. Always use fender washers at least 1.5 inch in diameter and 1/16 inch thick under the eyebolt to distribute the load on the enclosure.

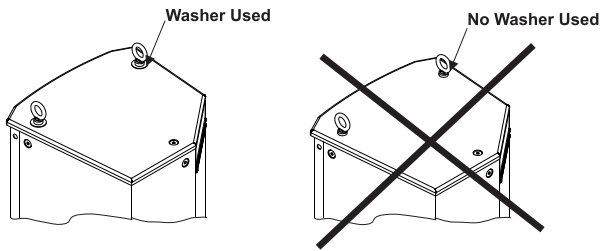

Figure 5.2: Eyebolt shown with and without washer

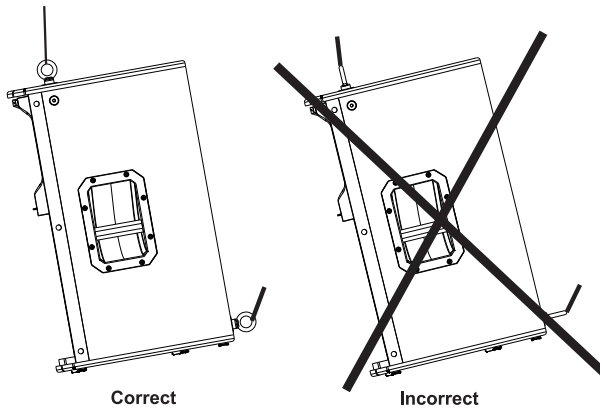

Figure 5.3: Eyebolts shown oriented in the plane of pull



Warning!

Never exceed the limitations or maximum recommended working load for Electro-Voice loudspeakers. Disregarding this warning could result in serious injury or death.

50 lb per Suspension Point

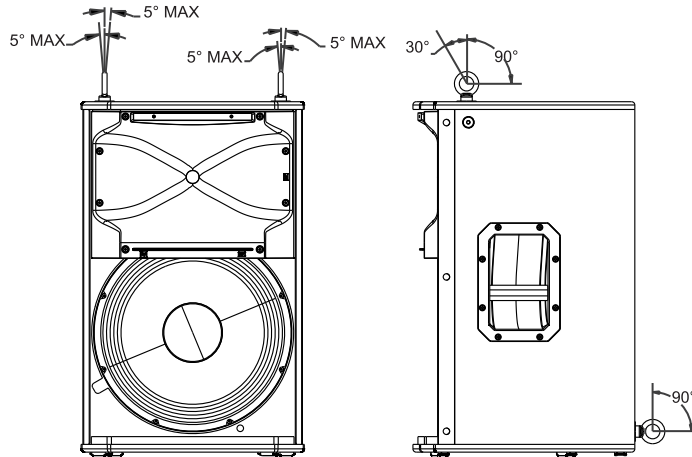

Figure 5.4: Maximum working load - vertical orientation



Warning!

Never suspend EKX Series loudspeakers in a vertical column array. Disregarding this warning could result in serious injury or death.

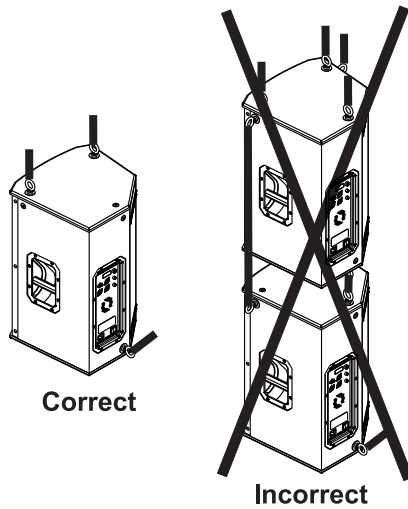

Figure 5.5: Loudspeaker vertical suspension

6 Amplifier DSP

6.1 Amplifier DSP controls

The amplifier has a combination of controls and connectors to ensure the most versatile loudspeaker system.

Full-Range loudspeaker control and monitoring interface

The full-range loudspeaker DSP control menu selections are available for the EKX-12P and EKX-15P.

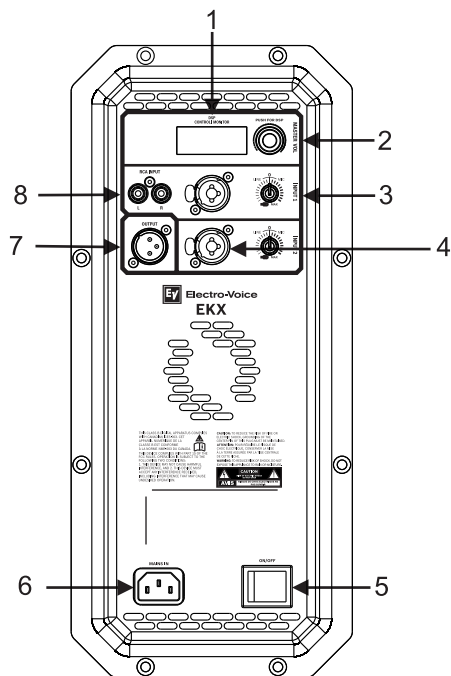

Figure 6.1: Full-Range loudspeaker amplifier panel

1. **LCD** – DSP control and monitoring interface.
2. **MASTER VOL** – Adjusts the sound level.
DSP – Scroll through the menu and select the available choices. Push the MASTER VOL knob to enter the DSP menu.
3. **INPUT LEVEL** – Level control for adjusting the individual inputs' level. The 12 o'clock position is unity gain (no gain or attenuation), the range to the left of zero (0) is for adjusting line level sources, and the range to the right of zero (0) is for adjusting microphone levels. LINE and MIC input level control is available for both INPUT 1 and INPUT 2.
4. **INPUT** – Balanced input for the connection of signal sources like mixing consoles, instruments, or microphones. Connections can be established using ¼ inch TRS or XLR connectors.
5. **POWER** – AC switch or switching the power ON or OFF. The LCD screen lights up when the power is turned ON, after approximately 3 seconds.
6. **MAINS IN** – AC connection is established via an IEC-connector.
7. **OUTPUT** – XLR output sends the mix of both input signals to another loudspeaker or subwoofer. INPUT LEVEL controls the signal level to OUTPUT. The MASTER VOL or DSP control settings do not affect OUTPUT.
8. **RCA INPUT** – Stereo unbalanced RCA inputs for connecting external audio media devices, such as MP3 players. Both RCA inputs are summed and can be controlled with INPUT 1 level. The inputs can be used simultaneously with XLR/TRS INPUT 1.

Subwoofer control and monitoring interface

The subwoofer DSP control menu selections are available for the EKC-15SP and EKC-18SP.

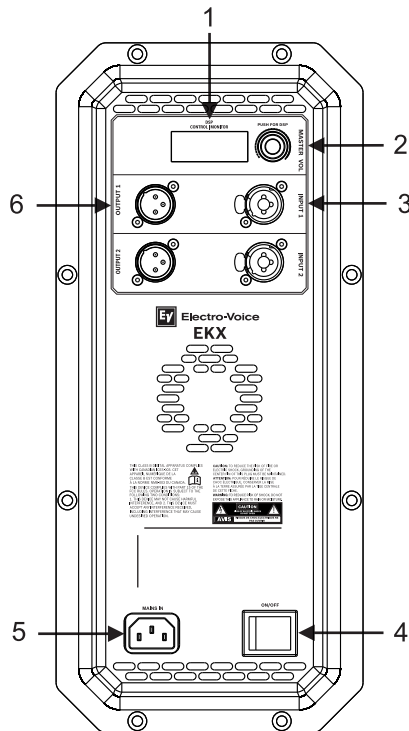

Figure 6.2: Subwoofer amplifier panel

1. **LCD** – DSP control and monitoring interface.
2. **MASTER VOL** – Adjusts the sound level.
DSP – Scroll through the menu and select the available choices. Push the MASTER VOL knob to enter the DSP menu.
3. **INPUT** – Balanced input for the connection of signal sources like mixing consoles, instruments, or microphones. Connections can be established using ¼ inch TRS or XLR connectors.
4. **POWER** – AC switch or switching the power ON or OFF. The LCD screen lights up when the power is turned ON, after approximately 3 seconds.
5. **MAINS IN** – AC connection is established via an IEC-connector.
6. **OUTPUT** – XLR output sends the input signal to another loudspeaker or subwoofer. INPUT 1 is linked to OUTPUT 1 and INPUT 2 is linked to OUTPUT 2. The MASTER VOL or DSP control settings do not affect OUTPUT.
7. **POWER** – AC switch for switching the power ON or OFF. The LCD screen lights up when the POWER is turned ON.

6.2 System status

Normal



Figure 6.3: Normal system status home screen

1. **LEVEL** – Indicates the master gain of the system in dB. The range is from mute to +10 dB, in 1 dB increments.
2. **IN1** – VU meter displays the signal level of INPUT 1 into the amplifier INPUT 1 XLR connector. IN1 and IN2 are independent of each other.
3. **IN2** – VU meter displays the signal level of INPUT 2 into the amplifier INPUT 2 XLR connector. IN1 and IN2 are independent of each other.
4. **Lock** – is designed to prevent users from inadvertently changing settings. Available options for this selection are: ON or OFF. The default is OFF.

System protection

System protection limiters indicate when a system is exceeding recommended usage by indicating **CLIP** or **LIMIT** on the LCD display.

CLIP



Figure 6.4: Clipping system status

CLIP indicates the signal to the loudspeaker is too high, resulting in a clipped signal into the loudspeaker. If **CLIP** is shown, reduce the input gain knob and/or the signal on the mixer or source equipment.

LIMIT



OR

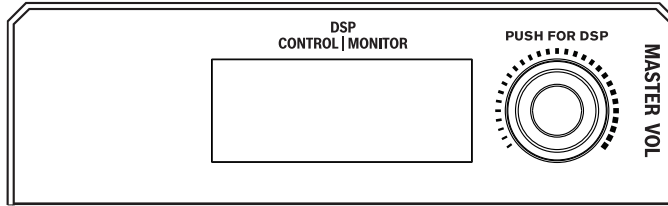

Figure 6.5: Limit system status

LIMIT protects the loudspeaker from short-term peaks which can cause distortion. When **LIMIT** is shown small on the screen, the limiter is active but keeps distortion under control. The large **LIMIT** indicates the sound is negatively affected. Reducing the output volume (**MASTER VOL**) is strongly recommended when the large limit indication is shown.

6.3 DSP controls

An integrated DSP control menu allows the user to select multiple DSP system settings on the loudspeaker.



To access the DSP controls menu, do the following:

1. Push the MASTER VOL knob.

The DSP Control menu appears.

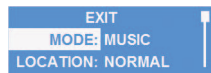

2. Using the MASTER VOL knob, scroll through the menu items.
3. Push the MASTER VOL knob to select the menu item you want to modify.

The focus moves to the parameters on the right side of the DSP menu.

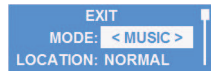

4. Using the MASTER VOL knob, scroll through the parameters.

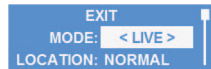

5. Push the MASTER VOL knob to confirm the selected parameter.
The setting is saved. The focus returns to the menu items on the left side of the DSP menu.



6. Repeat steps 2 through 5 to modify additional DSP and system settings.
7. Select EXIT to return to the home screen.

1. Push the **MASTER VOL** knob to select the menu item you want to modify.
The focus moves to the parameters on the right side of the DSPcontrol menu.
2. Using the **MASTER VOL** knob, scroll through the parameters.

6.3.1

Full-Range loudspeaker DSP control menu

The full-range loudspeaker DSP control menu selections are available for the EKX-12P and EKX-15P loudspeakers.

EXIT	
MODE	MUSIC (Default)
	LIVE
	SPEECH
	CLUB
LOCATION	TRIPOD (Default)
	MONITOR
	WALL
	SUSPEND
SUB	OFF (Default)
	80Hz
	100Hz
	120Hz
	150Hz
	EKX-15SP
	EKX-18SP
	ELX118P
TREBLE	0 db (Default)
	-12 dB to +6 dB
MID	0 db (Default)
	-12 dB to +6 dB
BASS	0 db (Default)
	-12 dB to +6 dB
LED	ON (Default)
	OFF
	LIMIT
LCD DIM	ON (Default)
	OFF

BRIGHT	5 (Default)
	1 to 10
CONTRAST	5 (Default)
	1 to 10
STORE	EXIT, 1, 2, 3, 4, 5, EXIT
RECALL	EXIT, 1, 2, 3, 4, 5, EXIT
LOCK	NO (Default)
	YES
RESET	NO (Default)
	YES
INFO	[PRODUCT NAME]
	[FIRMWARE VERSION]
EXIT	

Table 6.1: Full-Range Loudspeaker DSP Control Menu

EXIT menu

The **EXIT** menu is used to return to the home screen.



Notice!

The display returns to the home screen after two minutes of inactivity.

MODE menu

Available options for this selection are: **MUSIC**, **LIVE**, **SPEECH** and **CLUB**.

- **MUSIC** - is used for recorded music playback and electronic dance music applications.
- **LIVE** - is used for live sound applications.
- **SPEECH** - is used for spoken word applications.
- **CLUB** - is used for recorded electronic music playback.

LOCATION menu

The **LOCATION** menu is used to optimize the loudspeaker for different boundaries.

Available options for this selection are: **TRIPOD**, **MONITOR**, **WALL**, and **SUSPEND**.

- **TRIPOD** - is used when the loudspeaker is placed on a tripod stand or placed on a pole. (Default)
- **MONITOR** - is used when the loudspeaker is placed on the angled monitor panel in monitor position. This setting compensates for the amount of low frequency boost created by placing the speaker close to the floor.
- **WALL** - is used when the loudspeaker is mounted to the wall using the mounting bracket (Mounting Bracket accessory sold separately). This setting compensates for the amount of low frequency boost created by placing the loudspeaker close to the wall. If used on a column, it is recommended to use the **SUSPEND** mode.

- **SUSPEND** – is used when the loudspeaker is suspended in a 3-point suspension by eyebolts.

SUB menu

The **Sub** menu is used to select a high pass frequency for use with a subwoofer or a matched subwoofer.

Available options for this selection are: OFF, 80Hz, 100Hz, 120Hz, 150Hz, EKX-15SP, EKX-18SP, and ELX118P . The high passes are 24 dB/octave Linkwitz/Riley crossovers. The 80 Hz, 100 Hz, 120 Hz, and 150 Hz choices are generic high pass settings for use with other subwoofers. The EKX-15SP, EKX-18SP, and ELX118P settings are specifically optimized for subwoofers by including delay for best summation.

TREBLE menu

The **TREBLE** menu is used to adjust the high frequency performance of the loudspeaker for different applications or personal preference. The parameter controls a high shelving filter that is centered on 6 kHz.

The range is -12 dB to +6 dB.

The default is zero.

MID Menu

The **Mid** menu is used to adjust the midrange frequency performance of the loudspeaker for different applications or personal preference. The parameter controls a parametric EQ that is centered on 3.0 kHz.

The range is -12 dB to +6 dB.

The default is zero.

BASS menu

The **BASS** menu is used to adjust the low frequency performance of the loudspeaker for different applications or personal preference. The parameter controls a parametric EQ filter that is centered on 60 Hz.

The default is zero.

LED menu

The **LED** menu shows power on and indicates limit. Available options for this selection are:

ON, **OFF** or **LIMIT**.

- **ON** - turns the LED on when the power to the loudspeaker is ON.
- **OFF** - turns the LED off.
- **LIMIT** - turns the LED off under normal operation. The LED brief blinking indicates the limiter is activating. Short-term blinking is not critical because the integrated limiter keeps distortion under control. Constant lighting of the LED indicates the sound is negatively affected. If the LED is constantly lit, check the rear LCD for more information. Reducing the output volume is strongly recommended.

The default is **ON**.

LCD DIM menu

The **LCD DIM** menu is used to dim the display when the display is idle for two minutes.

Available options for this selection are: **ON** or **OFF**.

The default is **ON**.

BRIGHT menu

The **BRIGHT** menu is used to determine the brightness of the LCD. The range is 1 to 10. The default is five.

CONTRAST menu

The **CONTRAST** menu is used to increase or decrease the visibility of the LCD screen based on lighting conditions. The range is 1 to 10. The default is five.

STORE menu

The **Store** menu allows you create up to five customized user settings. Available options for this selection are: EXIT, 1, 2, 3, 4, and 5.



Notice!

The customized user setting name can contain a combination of alphanumeric characters including spaces. The alphanumeric character range is A to Z and 0-9. The name field length is 12 characters.

To store customized user settings, do the following:

1. From the DSP menu, scroll to STORE.
2. Push the MASTER VOL knob to select STORE.
The store screen appears.



3. Push the MASTER VOL knob to select 1.
The Enter name for 1 screen appears.
4. Use the MASTER VOL knob to scroll through the characters.
The characters appear.

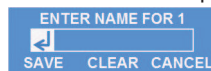

5. Push the MASTER VOL knob to select the desired character.
6. Turn the MASTER VOL knob to move to the next character entry.
Continue selecting characters until the desired name is entered.



7. Use the MASTER VOL knob to scroll to SAVE.
8. Push the MASTER VOL knob to select SAVE.
9. Repeat steps 3 through 8 to store additional customized user settings.
10. Select EXIT to return to the home screen.

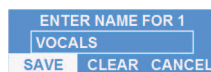

RECALL menu

The **Recall** menu allows you retrieve up to five customized user settings. Available options for this selection are: EXIT, 1, 2, 3, 4, and 5. To recall customized user settings, do the following:

1. From the DSP menu, scroll to **RECALL**.
2. Push the **MASTER VOL** knob to select **RECALL**.
The recall screen appears.
3. Push the **MASTER VOL** knob to select 1.
The selected item is loaded.



4. Select **EXIT** to return to the home screen.

LOCK menu

The **Lock** menu is designed to prevent users from inadvertently changing settings. Available options for this selection are: **ON** or **OFF**.

The default is **OFF**.

To **lock the DSP menu**, do the following:

1. From the DSP menu, scroll to **LOCK**.
2. Select **ON**.

The Menu lock message appears.



3. Select **YES**.



Notice!

If menu lock is **ON**, the user is allowed to adjust the **MASTER VOL**.

To **unlock the DSP menu**, do the following:

> Press and hold the **MASTER VOL knob** for five seconds.

The DSP menu unlocks.

RESET menu

The **RESET** menu is used to reset the loudspeaker to original factory settings. Available options for this selection are: **NO** or **YES**.

The default is **NO**.

To reset the system to original factory settings, do the following:

1. From the DSP menu, select **RESET**.

The reset are you sure message appears.



2. Select **YES**.

The loudspeaker restarts and resets the system to the original factory settings.



Notice!

Performing a reset erases the user customized settings saved under the **STORE** menu. The five user customized settings in the **STORE** and **RECALL** menus return to <EMPTY>.

INFO menu

The **INFO** menu is used to display the product name and firmware version.

The **MODE** menu is used to configure the type of sound the loudspeaker delivers.

6.3.2

Subwoofer DSP control menu

The subwoofer DSP control menu selections are available for the EKX-15SP and EKX-18SP subwoofers.

EXIT	
MODE	MUSIC (Default)
	LIVE
	CLUB
LOCATION	NORMAL (Default)
	CARDIOID
LOW PASS	80Hz
	100Hz (Default)
	120Hz
	150Hz
	EKX-12P
	EKX-15P
	ELX112P
	ELX115P
	ZLX-12P
	ZLX-15P
LED	ON (Default)
	OFF
	LIMIT
LCD DIM	ON (Default)
	OFF
BRIGHT	5 (Default)
	1 to 10
CONTRAST	5 (Default)
	1 to 10
STORE	EXIT, 1, 2, 3, 4, 5, EXIT
RECALL	EXIT, 1, 2, 3, 4, 5, EXIT
LOCK	NO (Default)
	YES
RESET	NO (Default)
	YES
INFO	[PRODUCT NAME]

	[FIRMWARE VERSION]
EXIT	

Table 6.2: Subwoofer DSP Control Menu

EXIT menu

The **EXIT** menu is used to return to the home screen.



Notice!

The display returns to the home screen after two minutes of inactivity.

MODE menu

The **Mode menu** is used to configure the type of sound the subwoofer delivers.

Available options for this selection are: MUSIC, LIVE, and CLUB.

- **MUSIC** - is used for recorded music playback and electronic dance music applications.
- **LIVE** - is used for live sound applications.
- **CLUB** - is used for recorded electronic music playback.

LOCATION menu

The **Location** menu is used to control output of the subwoofer when used in arrays with other subwoofers.

Available options for this selection are: NORMAL and CARDIOID.

- **NORMAL** - is used for a single subwoofer, or an array of subwoofers where the desired output is effectively omnidirectional. This setting should also be used for the front firing subwoofers in a cardioid array. Under most circumstances, the subwoofer should be set to NORMAL. (Default)
- **CARDIOID** - should ONLY be used on the rear firing subwoofers in cardioid arrays.

LOW PASS Menu

The **LOW PASS** menu is used to select low pass frequency for proper summation with a full-range loudspeaker.

Available options for this selection are: 80 Hz, 100 Hz, 120 Hz, 150 Hz, EKX-12P EKX-15P ELX112P, ELX115P, ZLX-12P, and ZLX-15P

The low passes are 24 dB/octave Linkwitz/Riley slopes. The 80 Hz, 100 Hz, 120 Hz, and 150 Hz selections are generic low pass settings for use with other full-range loudspeaker systems. The EKX-12P EKX-15P ELX112P, ELX115P, ZLX-12P, and ZLX-15P settings are specifically optimized for full-range loudspeakers for best summation.

The default is 100 Hz.

LED menu

The **LED** menu shows power on and indicates limit. Available options for this selection are:

ON, OFF or **LIMIT**.

- **ON** - turns the LED on when the power to the loudspeaker is ON.
- **OFF** - turns the LED off.

- **LIMIT** - turns the LED off under normal operation. The LED brief blinking indicates the limiter is activating. Short-term blinking is not critical because the integrated limiter keeps distortion under control. Constant lighting of the LED indicates the sound is negatively affected. If the LED is constantly lit, check the rear LCD for more information. Reducing the output volume is strongly recommended.

The default is **ON**.

LCD DIM menu

The **LCD DIM** menu is used to dim the display when the display is idle for two minutes.

Available options for this selection are: **ON** or **OFF**.

The default is **ON**.

The range is 1 to 10.

BRIGHT menu

The **BRIGHT** menu is used to determine the brightness of the LCD.

The range is 1 to 10.

The default is five.

CONTRAST menu

The **CONTRAST** menu is used to increase or decrease the visibility of the LCD screen based on lighting conditions.

The range is 1 to 10.

The default is five.

STORE menu

The **Store** menu allows you create up to five customized user settings. Available options for this selection are: EXIT, 1, 2, 3, 4, and 5.



Notice!

The customized user setting name can contain a combination of alphanumeric characters including spaces. The alphanumeric character range is A to Z and 0-9.

The name field length is 12 characters.

To store customized user settings, do the following:

1. From the DSP menu, scroll to STORE.
2. Push the MASTER VOL knob to select STORE.

The store screen appears.



3. Push the MASTER VOL knob to select 1.
The Enter name for 1 screen appears.
4. Use the MASTER VOL knob to scroll through the characters.
The characters appear.

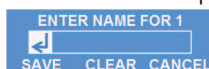

5. Push the MASTER VOL knob to select the desired character.
6. Turn the MASTER VOL knob to move to the next character entry.

Continue selecting characters until the desired name is entered.



- 7. Use the MASTER VOL knob to scroll to SAVE.
- 8. Push the MASTER VOL knob to select SAVE.

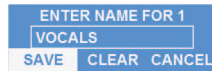

- 9. Repeat steps 3 through 8 to store additional customized user settings.
- 10. Select EXIT to return to the home screen.

RECALL menu

The **Recall** menu allows you retrieve up to five customized user settings. Available options for this selection are: EXIT, 1, 2, 3, 4, and 5.

To recall customized user settings, do the following:

- 1. From the DSP menu, scroll to RECALL.
- 2. Push the MASTER VOL knob to select RECALL.

The recall screen appears.

- 3. Push the MASTER VOL knob to select 1.

The selected item is loaded.



- 4. Select EXIT to return to the home screen.

LOCK menu

The **Lock** menu is designed to prevent users from inadvertently changing settings. Available options for this selection are: ON or OFF.

The default is **OFF**.

To **lock the DSP menu**, do the following:

- 1. From the DSP menu, scroll to **LOCK**.
- 2. Select **ON**.

The Menu lock message appears.



- 3. Select **YES**.



Notice!

If menu lock is **ON**, the user is allowed to adjust the **MASTER VOL**.

To **unlock the DSP menu**, do the following:

> Press and hold the **MASTER VOL knob** for five seconds.

The DSP menu unlocks.

RESET menu

The **RESET** menu is used to reset the loudspeaker to original factory settings. Available options for this selection are: **NO** or **YES**.

The default is **NO**.

To reset the system to original factory settings, do the following:

1. From the DSP menu, select RESET.
The reset are you sure message appears.



2. Select YES.
The loudspeaker restarts and resets the system to the original factory settings.

**Notice!**

Performing a reset erases the user customized settings saved under the STORE menu. The five user customized settings in the STORE and RECALL menus return to <EMPTY>.

INFO menu

The **INFO** menu is used to display the product name and firmware version.

7 Recommended configurations

7.1 Daisy-chaining full-range systems

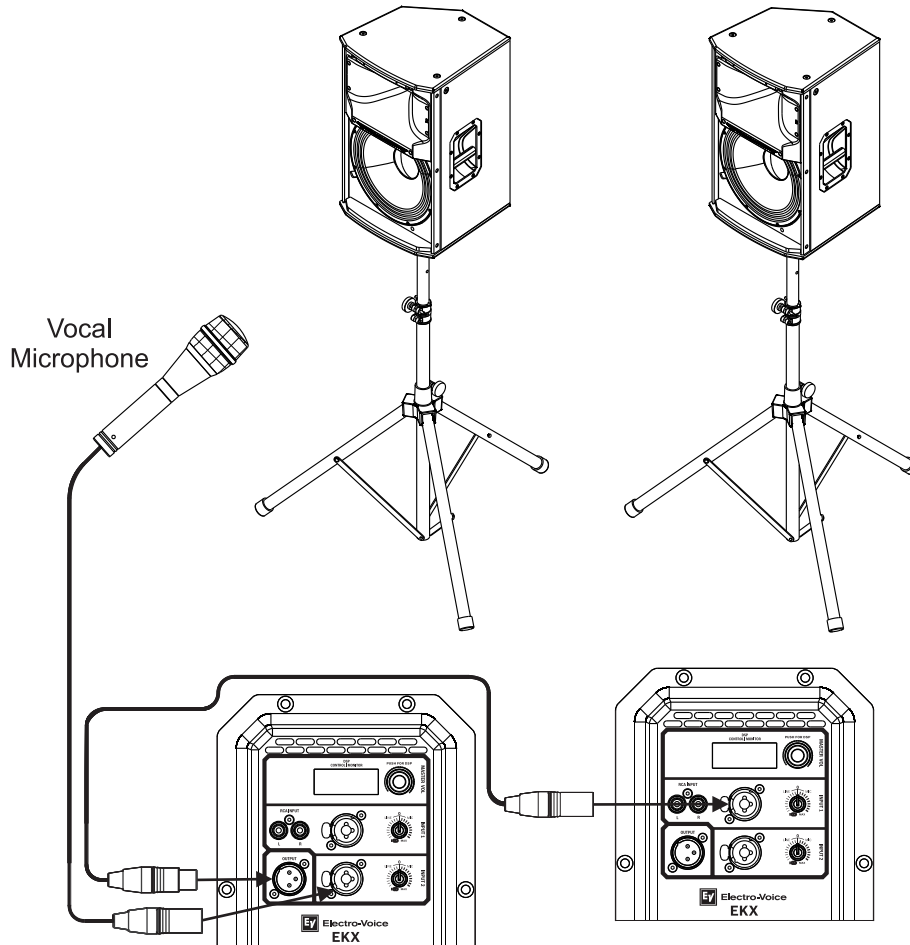

Notice!
The direction of the arrow indicates the signal path.

Mode:	Speech
Location:	Tripod
Sub:	Off

Table 7.3: DSP settings loudspeaker on a tripod

7.2 MP3 player MONO configuration

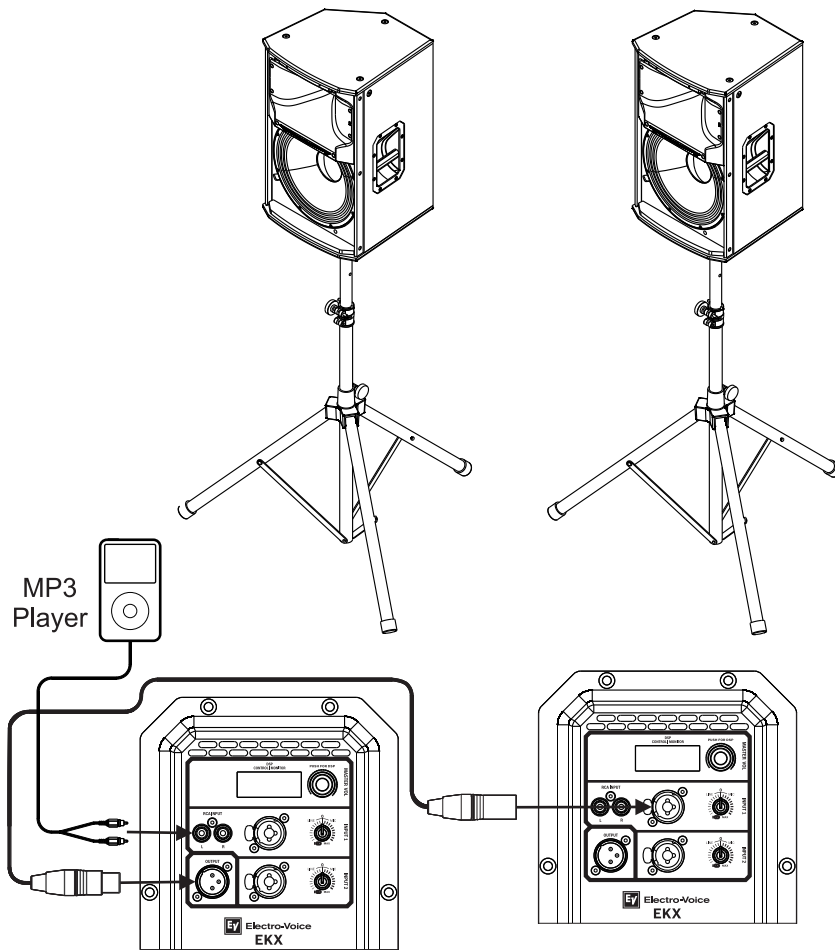

Notice!

The direction of the arrow indicates the signal path.

Mode:	Music
Location:	Tripod
Sub:	Off

Table 7.4: DSP settings loudspeaker on a tripod

7.3 MP3 player STEREO configuration

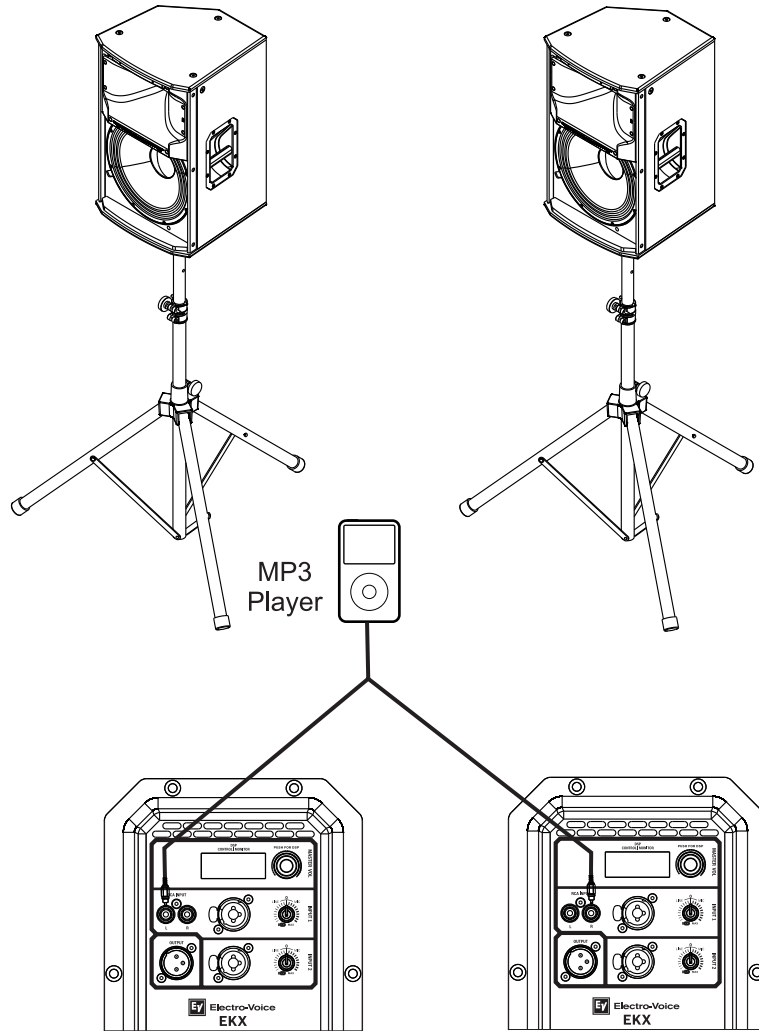

Mode:	Music
Location:	Tripod
Sub:	Off

Table 7.5: DSP settings loudspeaker on a tripod

7.4 Using full-range systems as monitors

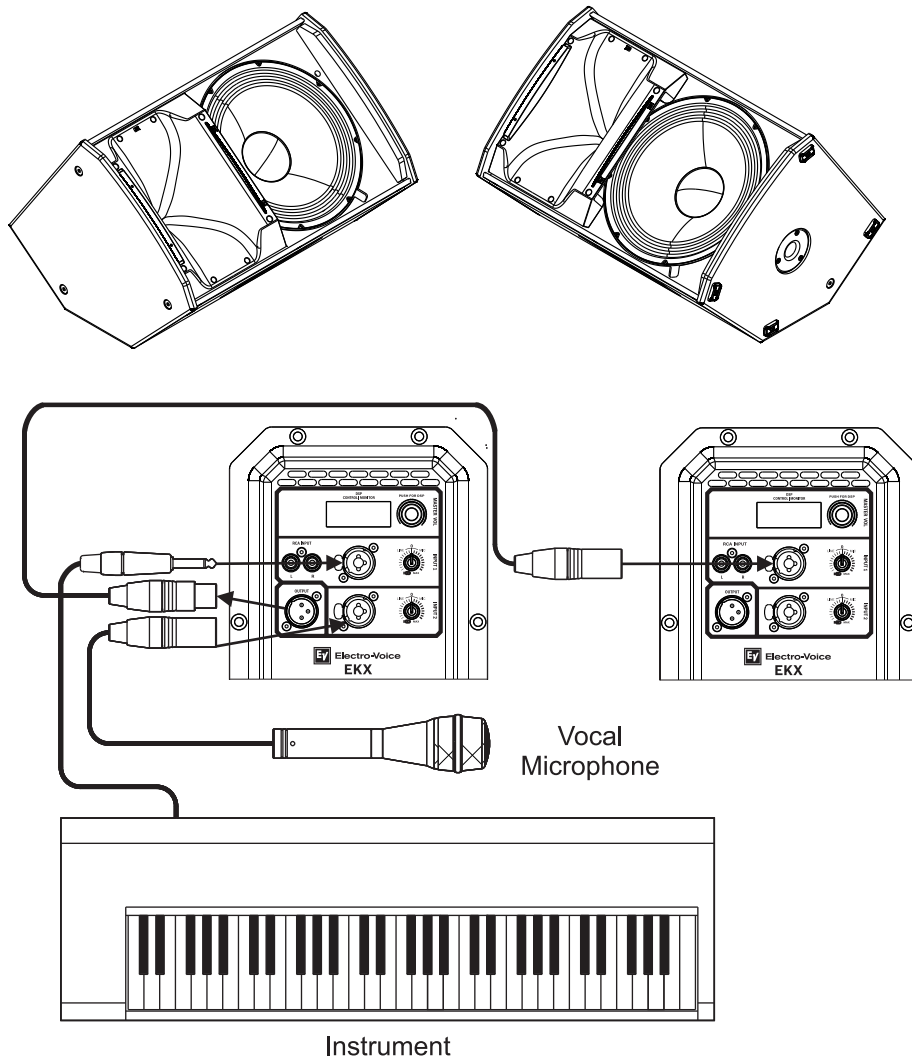

Notice!

The direction of the arrow indicates the signal path.

Mode:	Live
Location:	Monitor
Sub:	Off

Table 7.6: DSP settings loudspeakers as monitors

7.5 Stacking full-range systems with subwoofers

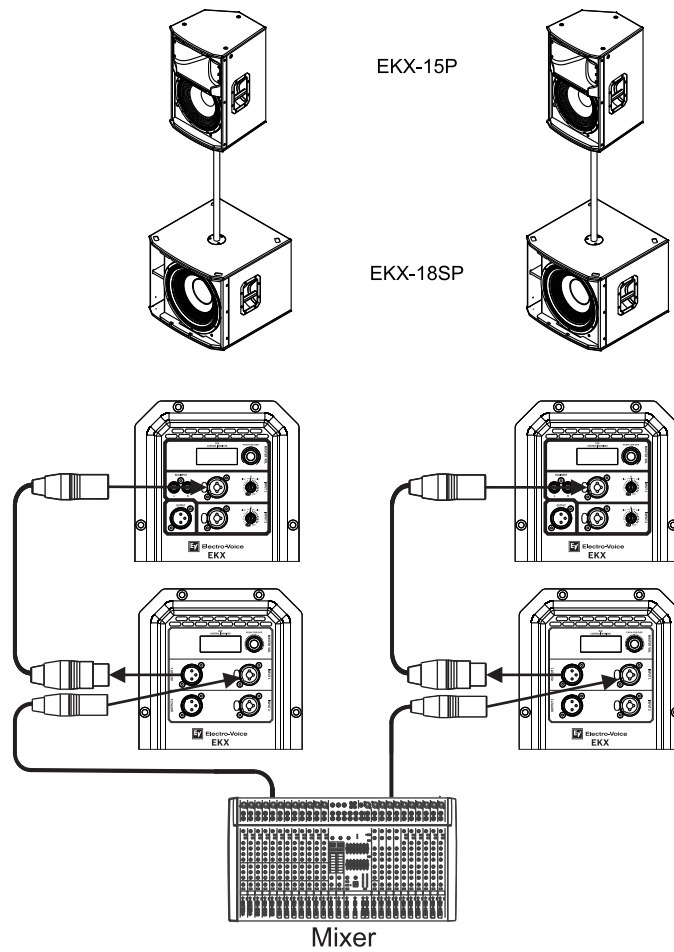

Notice!

The direction of the arrow indicates the signal path.

EKX-15P	
Mode:	Live
Location:	Tripod
Sub:	EKX-18SP
EKX-18SP	
Mode:	Live
Location:	Normal
Low Pass:	EKX-15P

Table 7.7: DSP settings loudspeaker and subwoofer stacked

7.6 Cardioid Control Technology

The EKX-15SP and EKX-18SP subwoofers have cardioid array processing originally developed for Electro-Voice concert subwoofer systems. Cardioid subwoofer arrays can be used to direct the output of an array of subwoofers in order to limit excessive amounts of bass in undesired areas. These arrays can be used to keep bass off of a stage, provide more consistent bass coverage in the audience, and reduces bass in the surrounding area.

Multiple EKX-15SP or EKX-18SP can be arrayed to create a cardioid polar pattern. See Cardioid pattern top view. The cardioid setting in the DSP menu is optimized to produce a rear rejection of up to 35 dB without any additional processing. The rejection may be less in smaller indoor environments than in larger outdoor environments. For best performance, adhere to the following guidelines:

The subwoofers must all be the same model, for example all - EKX-15SP or all - EKX-18SP.

- The subwoofers must be physically placed in one of the options shown. See Cardioid physical alignment.
- Front firing subwoofers use the NORMAL location setting, and rear firing subwoofers use the CARDIOID setting. All other settings should be the same between front and rear firing subwoofers.

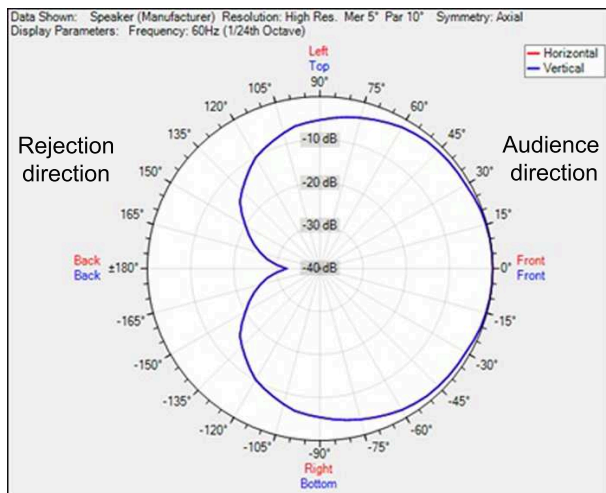

Figure 7.1: Cardioid pattern top view

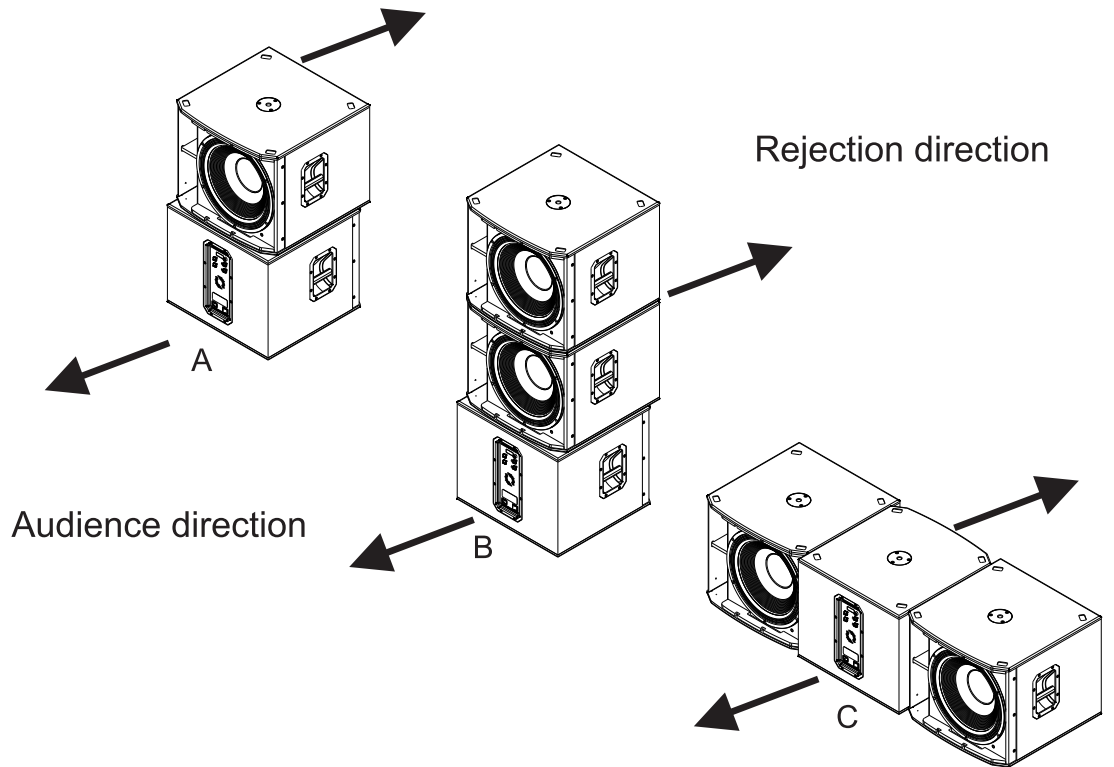

Figure 7.2: Cardioid physical alignment

Cardioid option A:

Either two EKX-15SP or two EKX-18SP subwoofers orientated vertically. Direct the top subwoofer towards the audience and the bottom subwoofer away from the audience (Rejection direction).

Cardioid option B:

Either three EKX-15SP or three EKX-18SP subwoofers orientated vertically. Direct the top two subwoofers towards the audience and the bottom subwoofer away from the audience (Rejection direction).

Cardioid option C:

Either three EKX-15SP or three EKX-18SP subwoofers orientated horizontally. Direct the left and right subwoofers towards the audience and the center subwoofer away from the audience (Rejection direction).

Subwoofers facing the audience	
Location:	Normal
Subwoofers facing away from the audience (Rejection direction)	
Location:	Cardioid

Table 7.8: Subwoofer cardioid

For more information about cardioid arrays, see EKX-15SP or EKX-18SP product pages on www.electrovoice.com.

Refer to

- *DSP controls, page 23*

8 Troubleshooting

Problem	Possible Cause(s)	Action
1. No sound	Amplifier	Connect a known working test loudspeaker to the amplifier outputs. If there is no sound, verify all the electronics are on, the signal routing is correct, the source is active; the volume is turned up, etc. Correct/repair/replace as necessary. If there is sound, the problem is wiring.
	Wiring	Verify you have connected the correct cables to the amplifier. Play something at a low level through the amplifier. Connect the test loudspeaker in parallel with the malfunctioning line. If the sound level is gone or is very weak, the line has a short in it (possibly a severe scrape, pinch, or a missed connection). Using the test loudspeaker, move down the line and test each connection/junction until you find the problem and correct it. Observe proper polarity.
2. Poor Low-Frequency Response	With SUB menu cross-over frequency activated	If no subwoofers are used with the system, select the OFF position.
3. Intermittent output such as cracking or distortion	Faulty connection	Check all connections at amplifier and loudspeakers to ensure they are all clean and tight. If the problem persists, check the wiring. See problem 1.
4. Constant noise such as buzzing, hissing or humming	Defective source or other electronic device	If noise is present, but no program material is playing, evaluate each component as necessary to isolate the problem. Most likely there is a break in the signal path.
	Poor system grounding or ground loop	Check and correct the system grounding, as required.
	Input gain knob is not in the MIC position	Slowly increase the input gain knob level to engage the microphone pre-amp.
5. No sound produced with microphone connected to INPUT 1 or INPUT 2	Microphone requires phantom power.	Use a dynamic microphone that does not require phantom power. If using a microphone requiring phantom power, an external phantom power source is needed
	Input gain knob is not in the MIC position	Slowly increase the input gain knob level to engage the microphone pre-amp.
6. Sound is distorted front LED is OFF, LCD screen LIMIT is ON	Excessive input level	Reduce the input level or loudspeaker level knobs to prevent limit.

Problem	Possible Cause(s)	Action
	Incorrect gain structure or source input (mixing console/preamp) is overdriven	Verify level controls of the source are properly structured by using the VU meter indicator on the LCD screen. If the VU meter bar is solid or the system indicates LIMIT, the input or source level is too high.
7. Microphone produces acoustic feedback when input level is amplified	Incorrect gain structure	Reduce the microphone levels at the mixing console or input source. If the microphone is connected directly to the speaker, reduce the input level on the speaker. Positioning the microphone close to the sound source increases gain-before-feedback. See problem 6.
	MODE is set to MUSIC	Change the MODE to LIVE or SPEECH.
	Microphone position is too close to the front of the loudspeaker	Whenever possible setup the loudspeakers so the microphone is behind them. If using the loudspeaker in a monitor position, aim the loudspeaker to the back of the microphone.
8. DSP menu is locked	The Menu Lock function has been turned on. A lock symbol displays on the LCD screen.	Press and hold the MASTER VOL knob for 5 seconds.
If these suggestions do not solve your problems, contact your nearest Electro-Voice dealer or Electro-Voice distributor.		

Refer to

- *System status, page 22*
- *DSP controls, page 23*

9 Technical data

EKX-12P and EKX-15P

	EKX-12P	EKX-15P
Freq. Response (-3 dB):	60 Hz - 18 kHz ¹	55 Hz - 18 kHz ¹
Freq. Range (-10 dB):	50 Hz - 20 kHz ¹	48 Hz - 20 kHz ¹
Maximum SPL:	132 dB ²	134 dB ²
Coverage (H x V):	90° x 60°	
Power Rating:	1500 W	
LF Transducer:	EVS-12M 300 mm (12 in)	EVS-15M 381 mm (15 in)
HF Transducer:	DH-1M 1-inch titanium compression driver	
Crossover Freq.:	1.7 kHz	
Connectors:	(1) Stereo RCA input, (2) XLR/TRS combo jack, and (1) XLR	
Enclosure:	15 mm plywood with EVCoat	
Grille:	18 AWG steel with powdercoat	
Suspension:	(8) M10 threaded mounting points	
Dimensions:	607 mm x 375 mm x 356 mm (24 in x 15 in x 14 in)	685 mm x 432 mm x 429 mm (27 in x 17 in x 17 in)
Net Weight:	18.8 kg (41.4 lb)	24.4 kg (53.9 lb)
Shipping Weight:	22.9 kg (50.4 lb)	29.5 kg (65.0 lb)
Power Consumption:	100 – 240 V~, 50 – 60 Hz, 1.8A ³	

¹Full space measurement using the music DSP preset.

²Maximum SPL is measured at 1 m using broadband pink noise at maximum output.

³Current rating is 1/8 power.

EKX-15SP and EKX-18SP

	EKX-15SP	EKX-18SP
Freq. Response (-3 dB):	45 Hz - 150 Hz ¹	40 Hz - 150 Hz ¹
Freq. Range (-10 dB):	40 Hz - 180 Hz ¹	35 Hz - 180 Hz ¹
Maximum SPL:	133 dB Peak ²	134 dB Peak ²
Power Rating:	1300 W	
LF Transducer:	EVS-15C 381 mm (15 in)	EVS-18C 457 mm (18 in)
Low Pass Frequency:	Adjustable: 80 Hz, 100 Hz, 120 Hz, 150 Hz	
Connectors:	(2) XLR/TRS combo jacks and (2) XLR link outputs	
Enclosure:	15 mm plywood with EVCoat	
Grille:	18 AWG steel with powdercoat	
Dimensions:	455 mm x 530 mm x 551 mm (18 in x 21 in x 22 in)	520 mm x 606 mm x 612 mm (20 in x 24 in x 24 in)
Net Weight:	26.2 kg (57.7 lb)	32.8 kg (72.4 lb)
Shipping Weight:	32.6 kg (71.8 lb)	41.2 kg (90.9 lb)
Power Consumption:	100 – 240 V~, 50 – 60 Hz, 1.8A ³	

¹Half Space Measurement.

²Maximum SPL is measured at 1 m using broadband pink noise at maximum output.

³Current rating is 1/8 power.

9.1 Frequency response

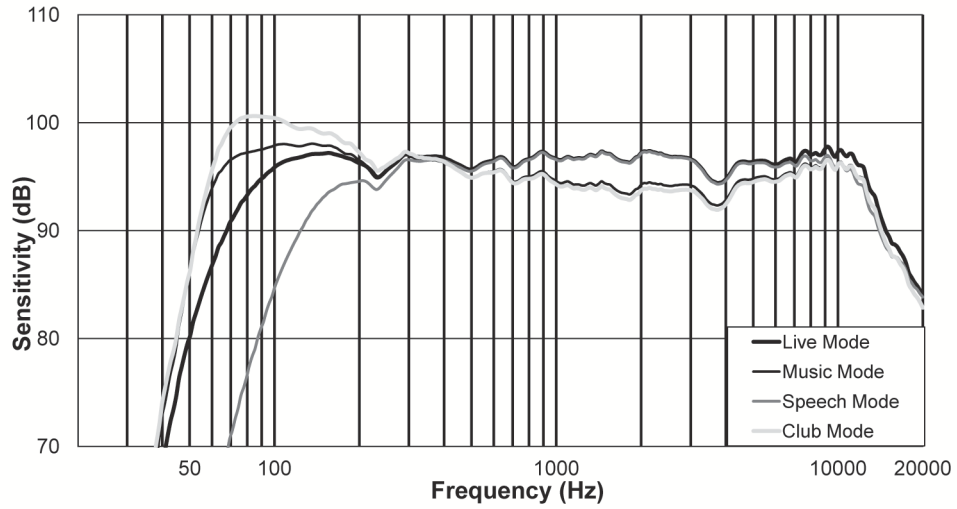

Figure 9.1: EKX-12P Frequency response graph: live, music, speech, and club modes

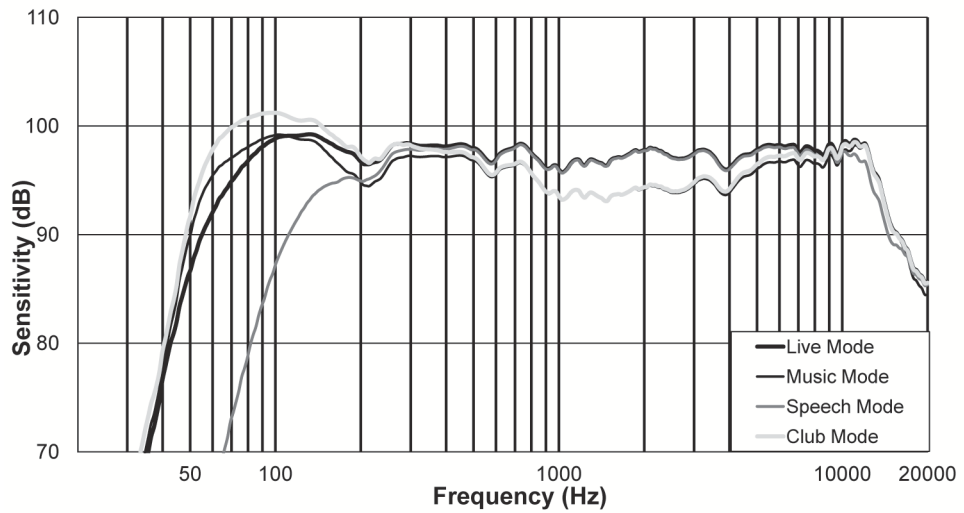

Figure 9.2: EKX-15P Frequency response graph: live, music, speech, and club modes

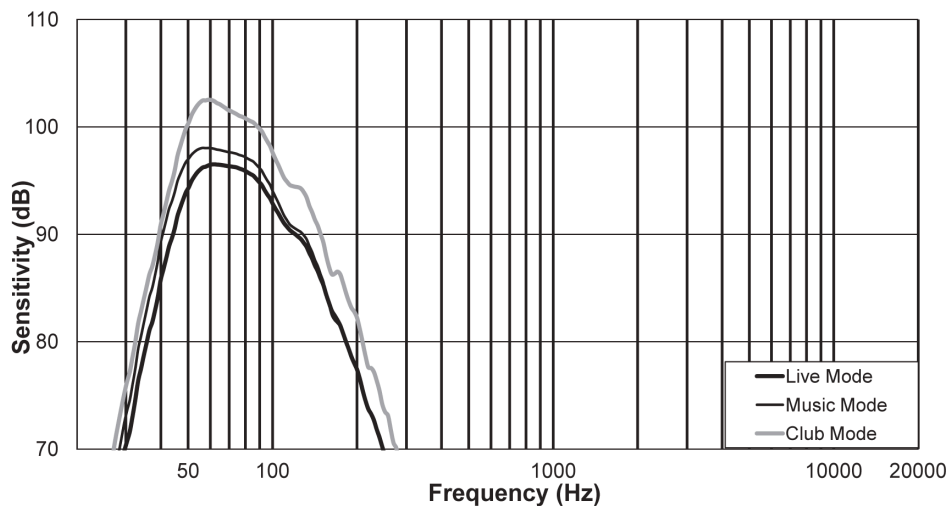

Figure 9.3: EKX-15SP Frequency response graph: live, music, and club modes

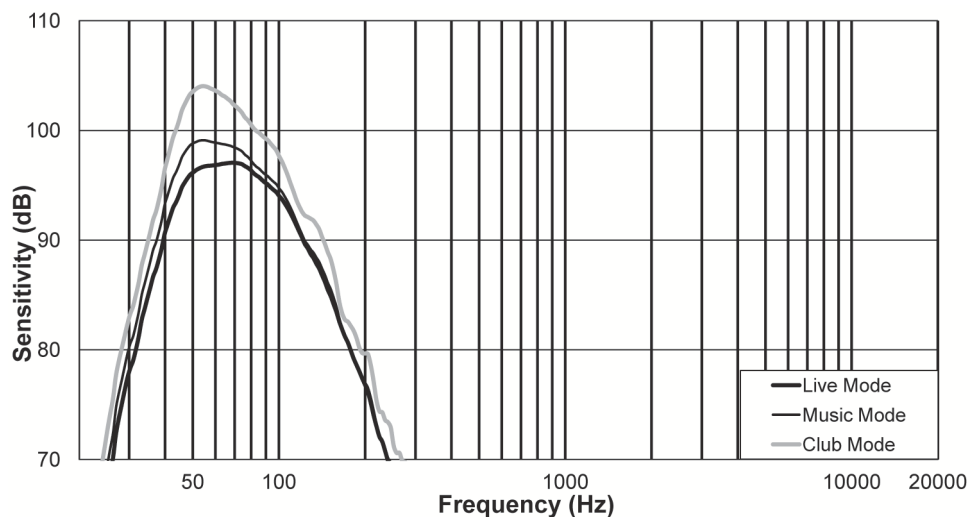
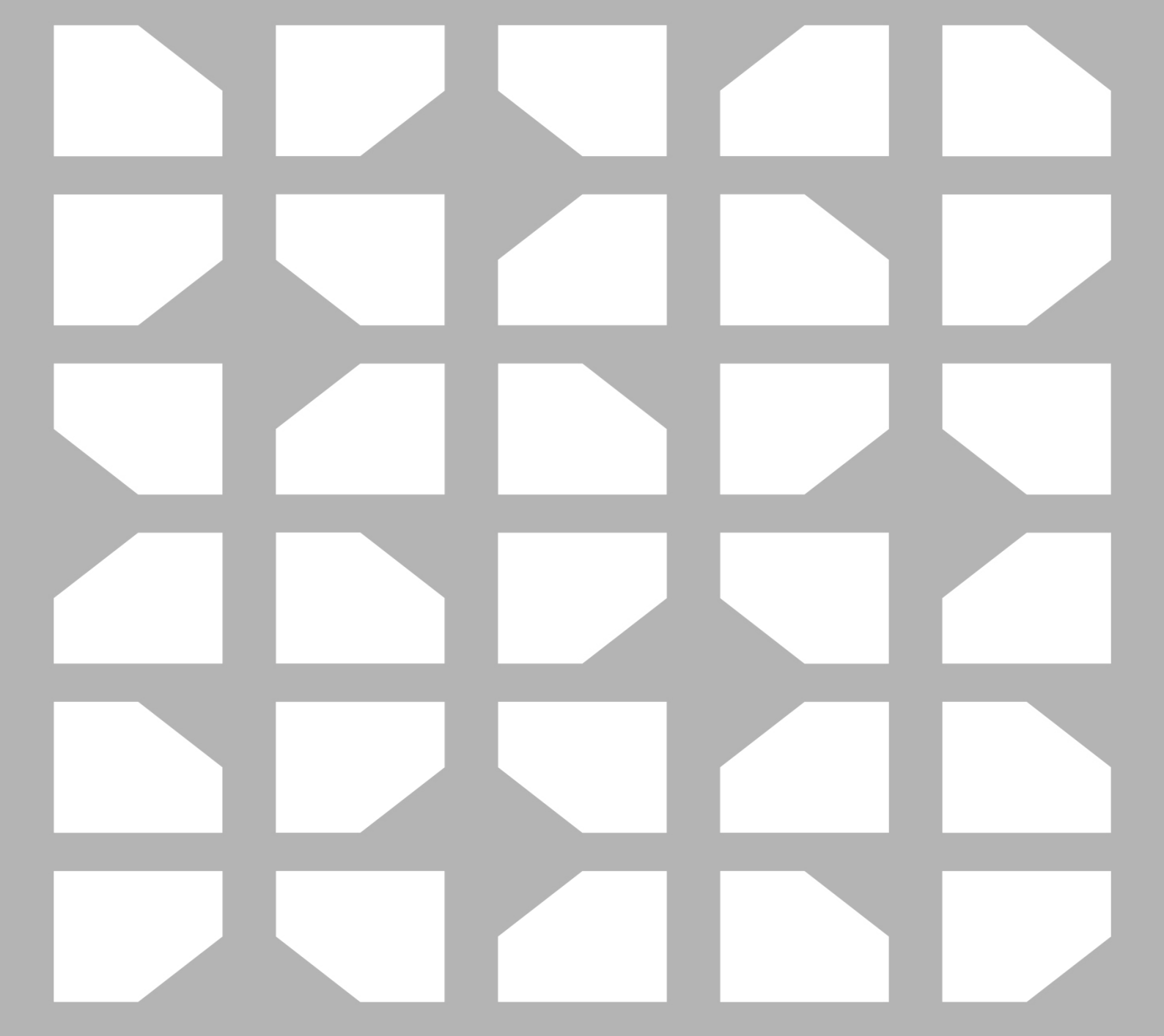

Figure 9.4: EKX-18SP Frequency response graph: live, music, and club modes



TELEX

12000 Portland Avenue South
Burnsville MN 55337

USA

www.telex.com

© Bosch Security Systems, LLC,
2022